



Station P2S

迷你主机

天启智能科技

V1.0





产品特点 Product features

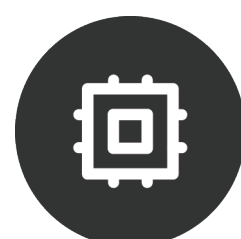

四核64位处理器

四核64位Cortex-A55 处理器RK3568
采用22nm先进工艺
主频高达2.0GHz，低功耗高性能

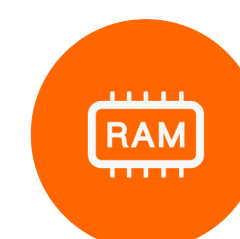

8GB LPDDR4大内存

最高可配8GB LPDDR4内存量，128GB的高速EMMC机身内存，每个操作都能享受风驰电掣般的加速



4K HDR H.265视频解码

OpenGL ES3.2/2.0, Vulkan1.1
4K@60fps H.265/VP9视频解码
1080P@100fps H.265视频编码
1TOPs算力NPU



支持SATA HDD存储扩展

支持2.5寸SATA SSD/HDD，让设备拓展至TB级，兼得高速读写与大容量存储的需求



支持多种操作系统

支持Android、Ubuntu、Linux+QT、Station OS等操作系统，可支持TF卡、U盘、EMMC等方式启动系统，提供个性化系统定制服务

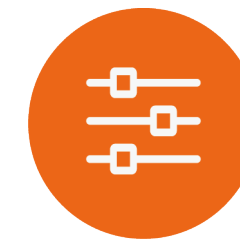

丰富的扩展接口

Control Port (RS232*2、RS485*1)、HDMI2.0、双千兆以太网 (RJ45)、USB3.0、USB2.0*2、USB-C (OTG)



规格参数 Specifications

类 型	主要参数
SOC	RK3568
CPU	四核64位Cortex-A55处理器, 22nm先进工艺, 主频最高2.0GHz
GPU	ARM G52 2EE图形处理器, 支持OpenGL ES 1.1/2.0/3.2, OpenCL 2.0, Vulkan 1.1, 内嵌高性能2D加速硬件
NPU	1Tops@INT8RKNN NPU AI 加速器, 支持Caffe/TensorFlow/TFLite/ONNX/PyTorch/Keras/Darknet架构模型一键转换
编解码	4K@60fps H.265/H.264/VP9视频解码, 1080P@60fps H.265/H.264视频编码
运行内存	2GB/4GB/8GB LPDDR4
机身存储	16GB/32GB/64GB/128GB eMMC, 内置存储 16MB SPI Flash
扩展存储	1*SATA 3.0 (可扩展 2.5寸7mm厚 SSD/HDD), 1*TF Card Slot
以太网	2*1000Mbps以太网 (RJ45)
无线网	2.4G/5GHz 双频WiFi, 802.11 a/b/g/n/ac、Bluetooth 5.0, 可扩展4G LTE网络通讯功能
视频输出	1*HDMI2.0 (4K@60Hz)
音频	1*HDMI音频输出, 1*3.5mm音频接口
USB	1*USB3.0 (限流 1A)、2*USB2.0 (限流 500mA)、1*USB-C (USB2.0 OTG)
串口	1*RJ45 Control Port (1*RS485 + 2*RS232)
电源	DC 12V (5.5*2.1mm接口, 支持 9V~24V 宽电压输入)
系统	支持Android、Ubuntu、Buildroot +QT、Station OS系统
尺寸	142mm * 89mm * 35.5mm
功耗	待机功耗: 0.3W (12V/25mA), 典型功耗: 4.2W (12V/350mA), 最大功耗: 7.8W (12V/650mA)
环境	工作温度: -20°C ~ 60°C, 存储温度: -20°C ~ 70°C, 存储湿度: 10% ~ 90%RH (无凝露)

接口描述 Interface description

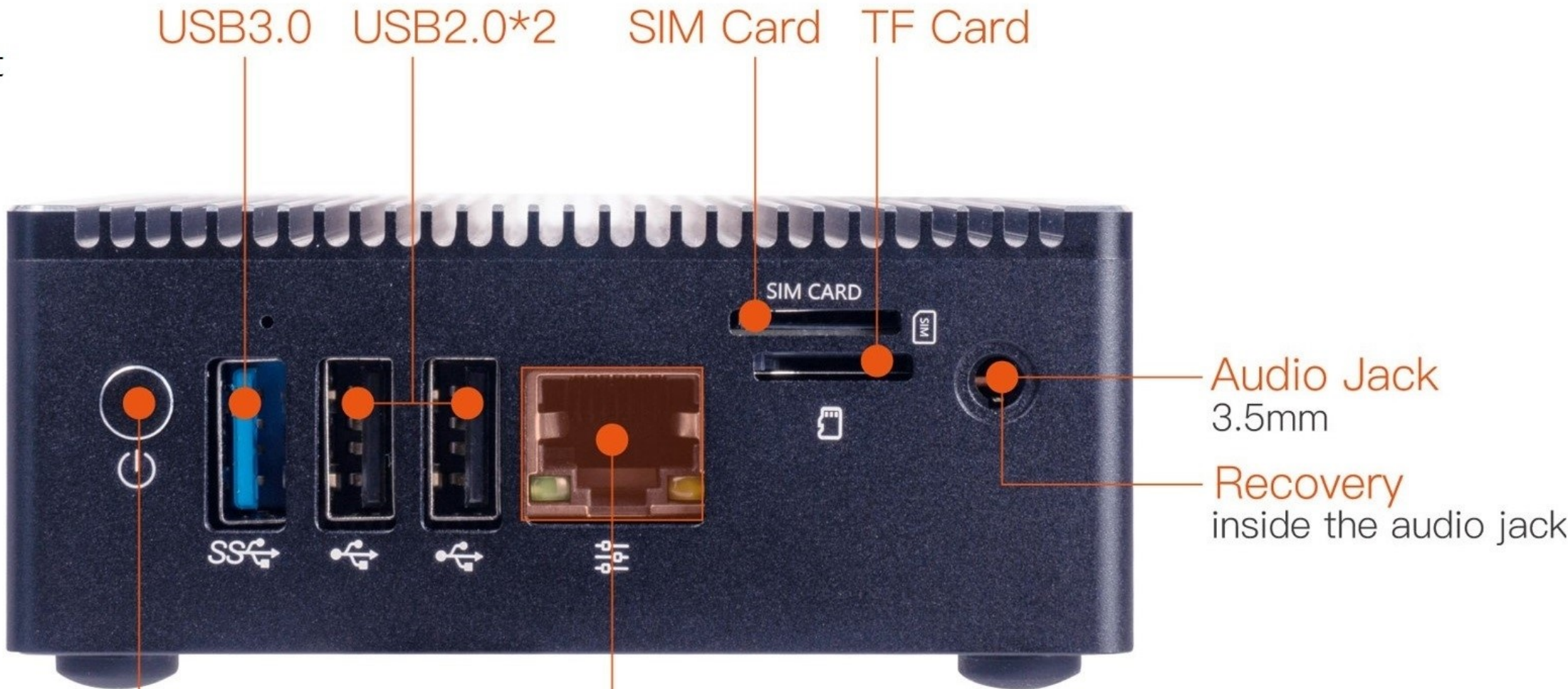

- Control Port
1. RS232_TX3
 2. RS232_RX3
 3. RS232_TX2
 4. GND
 5. GND
 6. RS232_RX2
 7. RS485_A
 8. RS485_B



产品尺寸 Dimension

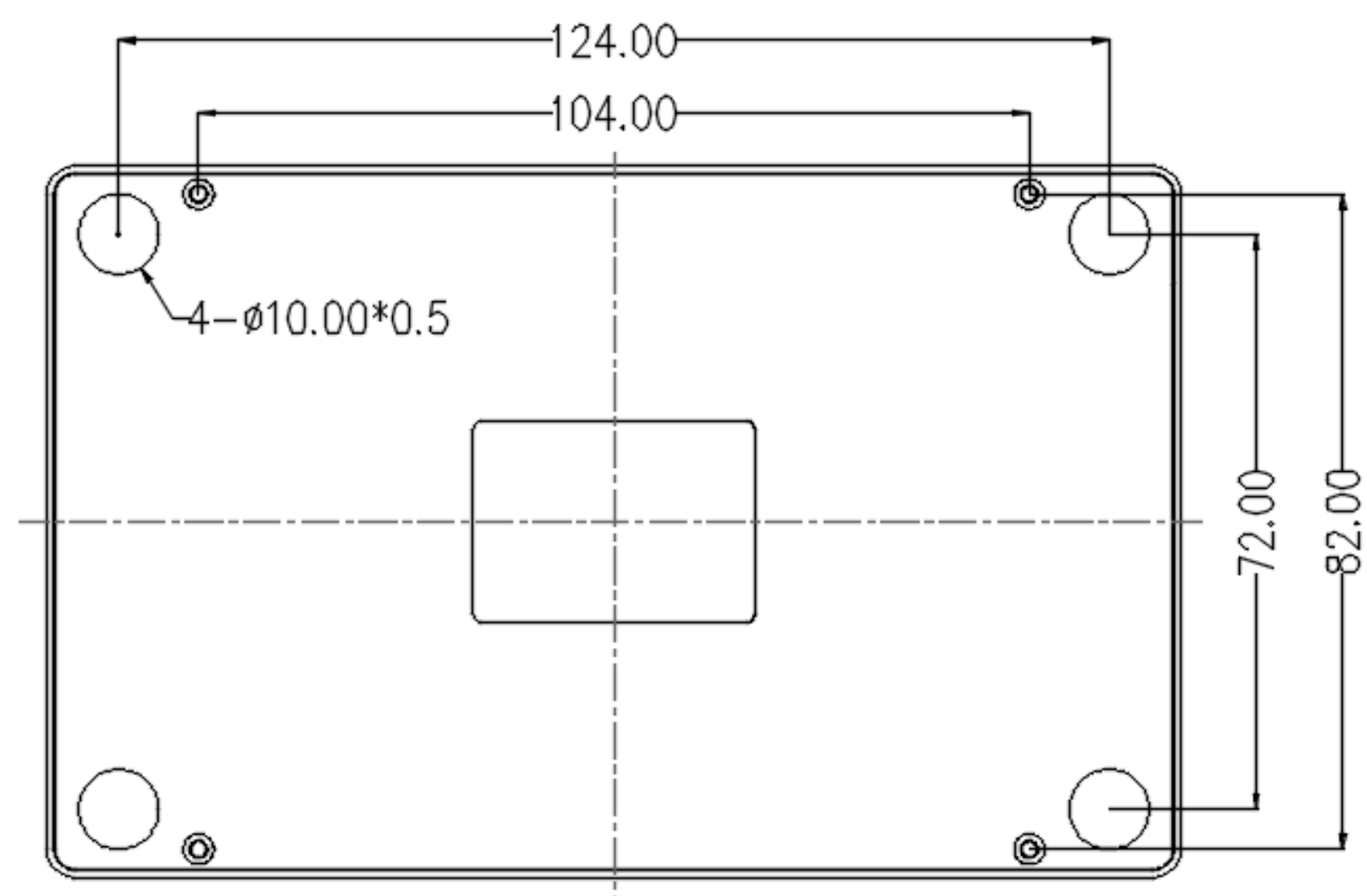
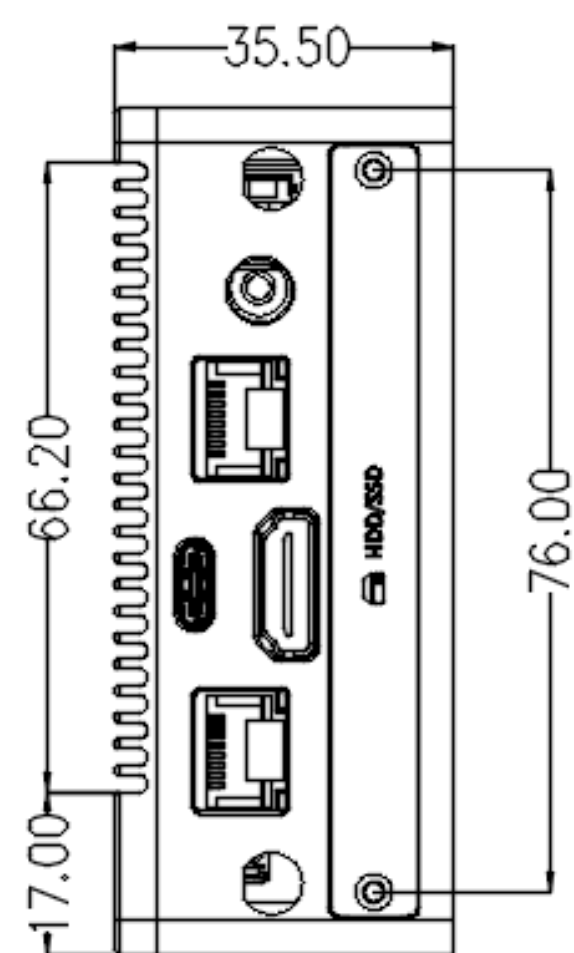
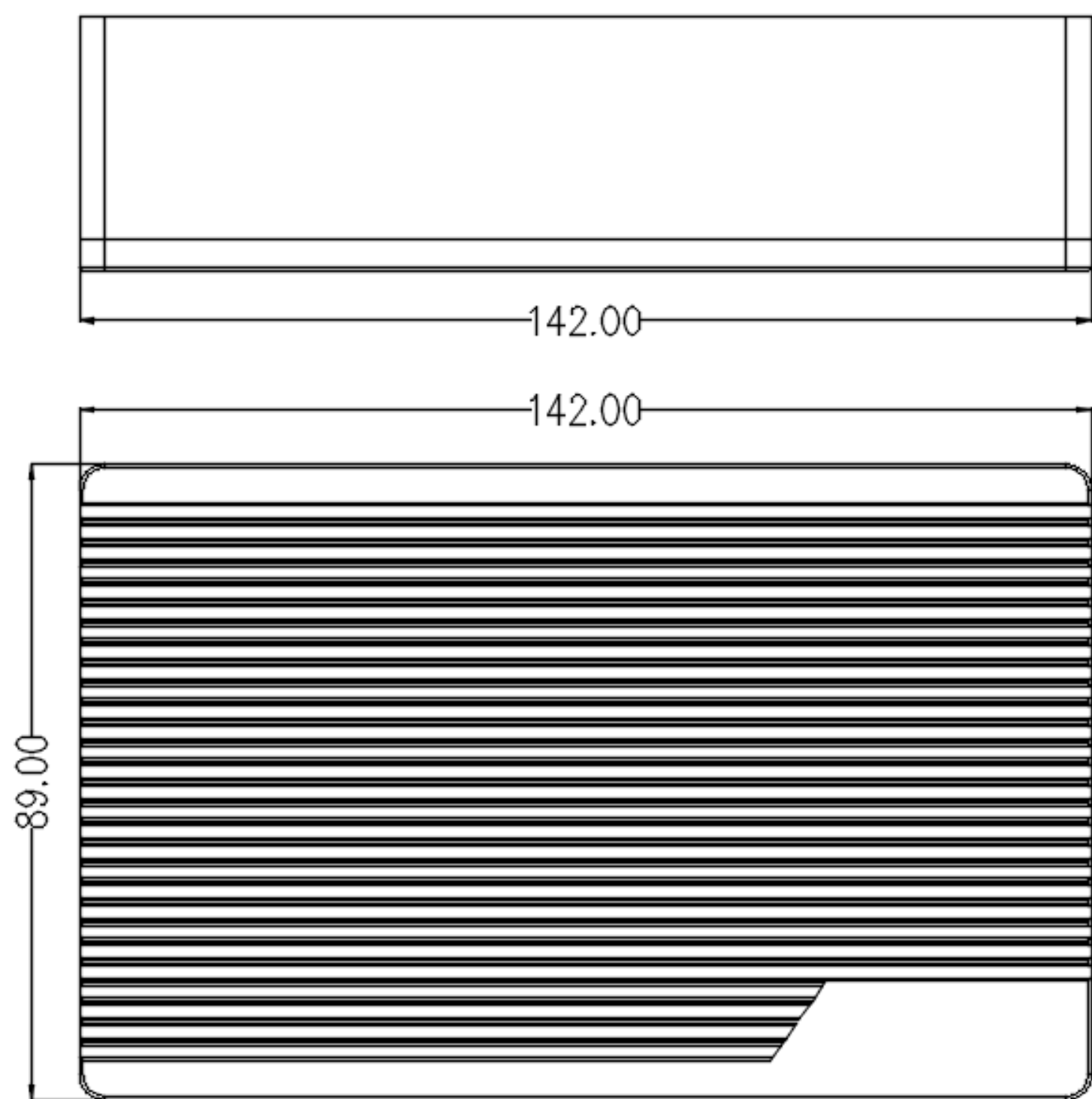



中山市天启智能科技有限公司

 联系方式
400-151-1533

 官方网址
www.t-firefly.com

 公司地址
广东省中山市东区中山四路57号宏宇大厦1座2101