



# 32T High-computing Power AI Computer

- EC-A1684XJD4
- EC-A1684XJD4 V2

V1.2 2025-3-5

T-CHIP INTELLIGENCE TECHNOLOGY





# Product features



## 32TOPS ultra-high computing power AI processor

Adopting SOPHON AI processor BM1684X, octa-core ARM Cortex-A53, the main frequency is up to 2.3GHz, and the computing power is up to 32TOPS (INT8).



## Powerful multi-channel video AI processing performance

It supports up to 32 channels of 1080P H.265/H.264, 1 channel of 8K H.265 video decoding, and supports 12 channels of 1080P H.265/H.264 video encoding.



## The private deployment of large language models

Support the private deployment of ultra-large-scale parameter models under the Transformer architecture, including large language models such as Llama series, ChatGLM series, and Qwen series, as well as large vision models like ViT, Grounding DINO, and SAM.



## Multiple deep learning frameworks

Support traditional network architectures such as CNN, RNN, and LSTM; a variety of deep learning frameworks, including TensorFlow, PyTorch, MXNet, PaddlePaddle, and ONNX, as well as custom operator development.

# Product features



## Private deployment of AIGC image generation models

Support the private deployment of the Stable Diffusion V1.5 image generation model in the AIGC field and Docker container management technology.



## Strong network communication capability

It supports dual Gigabit Ethernet, 2.4GHz/5GHz dual-band WiFi, and expandable 5G/4G network to meet the needs of different application scenarios.

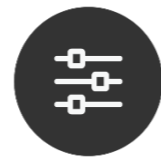

## Abundant expansion interfaces

With RS485, RS232, USB3.0, USB2.0, HDMI2.0 and other expansion interfaces, convenient data connection and communication, can be directly applied to AI edge computing products.



## Wide range of application scenarios

It is widely used in visual computing, edge computing, computing services, artificial intelligence, smart construction sites, smart transportation, smart classrooms, unmanned supermarkets, monitoring and security and other industries.

# Specifications



		EC-A1684XJD4	EC-A1684XJD4 V2	
Basic Specifications	SOC	SOPHON BM1684X		
	CPU	Integrated high-performance octa-core ARM A53, 12nm process, with a frequency of up to 2.3GHz		
	TPU	Built-in tensor computing module TPU, computing power up to: 32TOPS(INT8), 16TFLOPS(FP16/BF16), 2TFLOPS(FP32)		
	Codecs	32-channel H.265/H.264 1080P@25fps, 1-channel H.265 8K@25fps video decoding 32-channel 1080P@25fps HD video processing (decoding + AI analysis) 12-channel H.265/H.264 1080P@25fps video encoding JPEG image codec 1080P@600fps		
	RAM	8GB/12GB/16GB LPDDR4/LPDDR4X		
	Storage	32GB/64GB/128GB eMMC		
	Storage Expansion	1 × M.2 SATA3.0 (expandable 2242 SATA SSD, located inside the computer), 1 × TF Card	1 × M.2 SATA3.0 (expandable 2242 SATA SSD, located at the bottom of the computer), 1 × TF Card	
	Power	DC 12V (5.5×2.5mm)		
	Power consumption	Normal: 24W(12V/2000mA), Max: 42W(12V/3500mA)		
	OS	Linux		
	Software support	<ul style="list-style-type: none"> <li>• The private deployment of ultra-large-scale parameter models under the Transformer architecture, including large language models such as Llama series, ChatGLM series, and Qwen series, as well as major visual models like ViT, Grounding DINO, and SAM</li> <li>• The private deployment of the Stable Diffusion V1.5 image generation model in the AIGC field</li> <li>• Traditional network architectures such as CNN, RNN, and LSTM; a variety of deep learning frameworks, including TensorFlow, PyTorch, MXNet, PaddlePaddle, Caffe and ONNX, as well as custom operator development</li> <li>• Docker container management technology</li> </ul>		
	Size	210.0mm × 130.0mm × 44.5mm		
	Weight	Net weight: 1.28kg, Weight with antenna: 1.33kg, Total weight with package: 2.24kg		
	Environment	Operating Temperature: -20°C ~ 60°C, Storage Temperature:-20°C ~ 70°C, Storage Humidity: 10% ~ 90%RH(non-condensing)		
Interface Specifications	Ethernet	2 × Gigabit Ethernet (RJ45/1000Mbps)		
	Wireless network	Support 2.4GHz/5GHz dual-band WiFi (802.11a/b/g/n/ac protocol), expandable 4G LTE (via Mini PCIe), 5G (via M.2 B-KEY)		
	Video output	1 × HDMI2.0 (1080P@30Hz)		
	Audio	1 × HDMI audio output		
	USB	2 × USB3.0 (Max: 1A), 2 × USB2.0 (Max: 500mA)	2 × USB3.0 (Max: 1A), 2 × USB2.0 (Max: 500mA), 1 × Type-C(Debug)	
	Debug UART	1 × RS232 (DB9), 1 × RS485 (DB9)		
	Other interfaces	2 × WiFi antenna, 1 × Bluetooth antenna		



# Interface description



EC-A1684XJD4

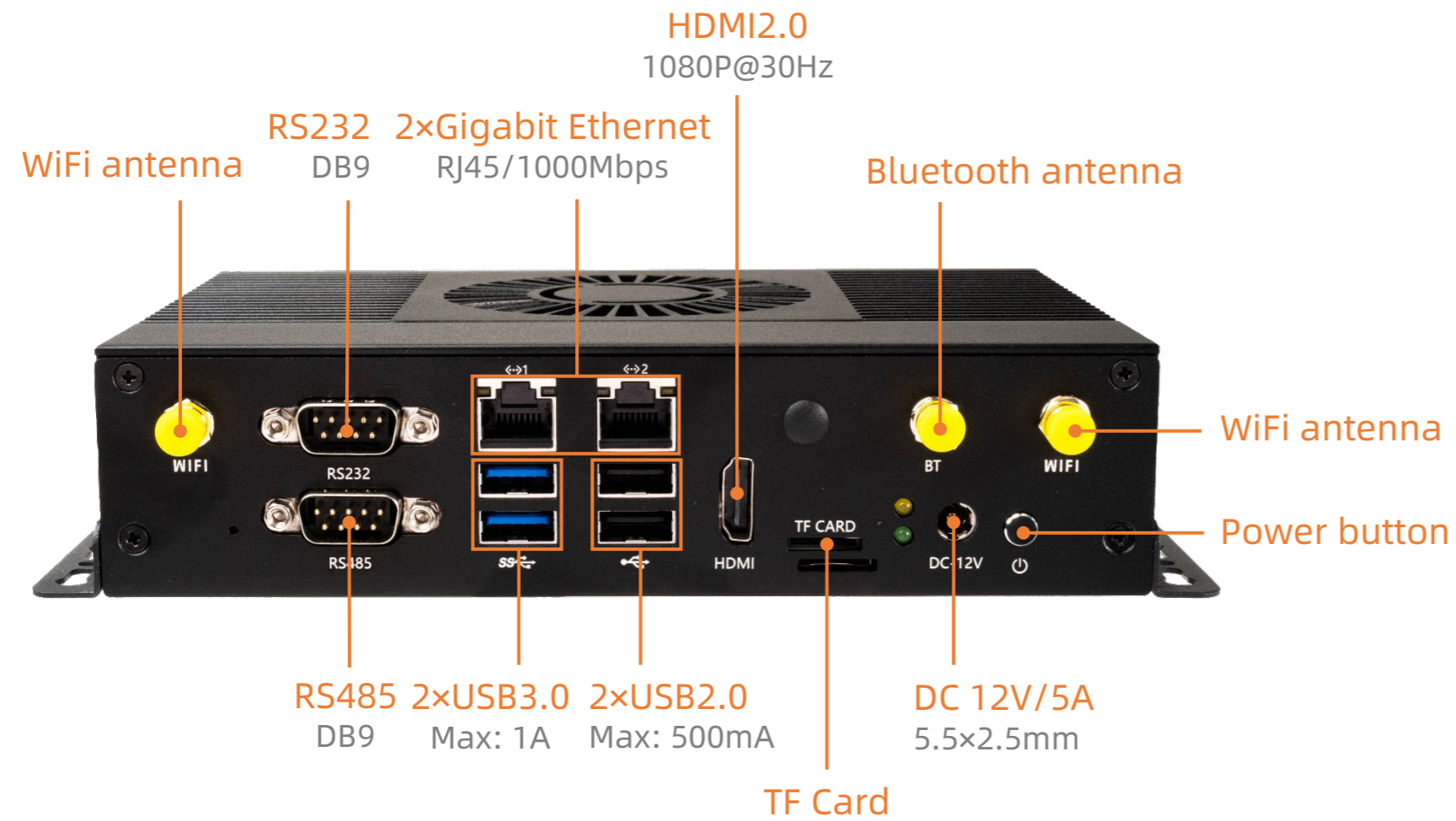

# Interface description

EC-A1684XJD4 V2

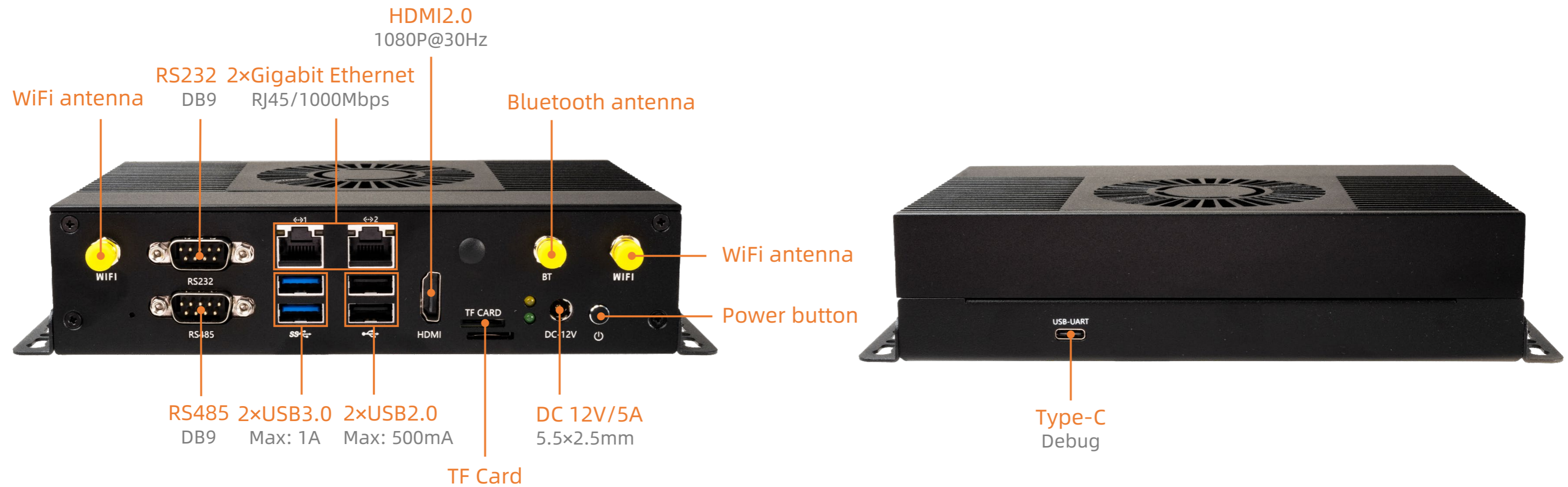



# Interface description



EC-A1684XJD4 V2

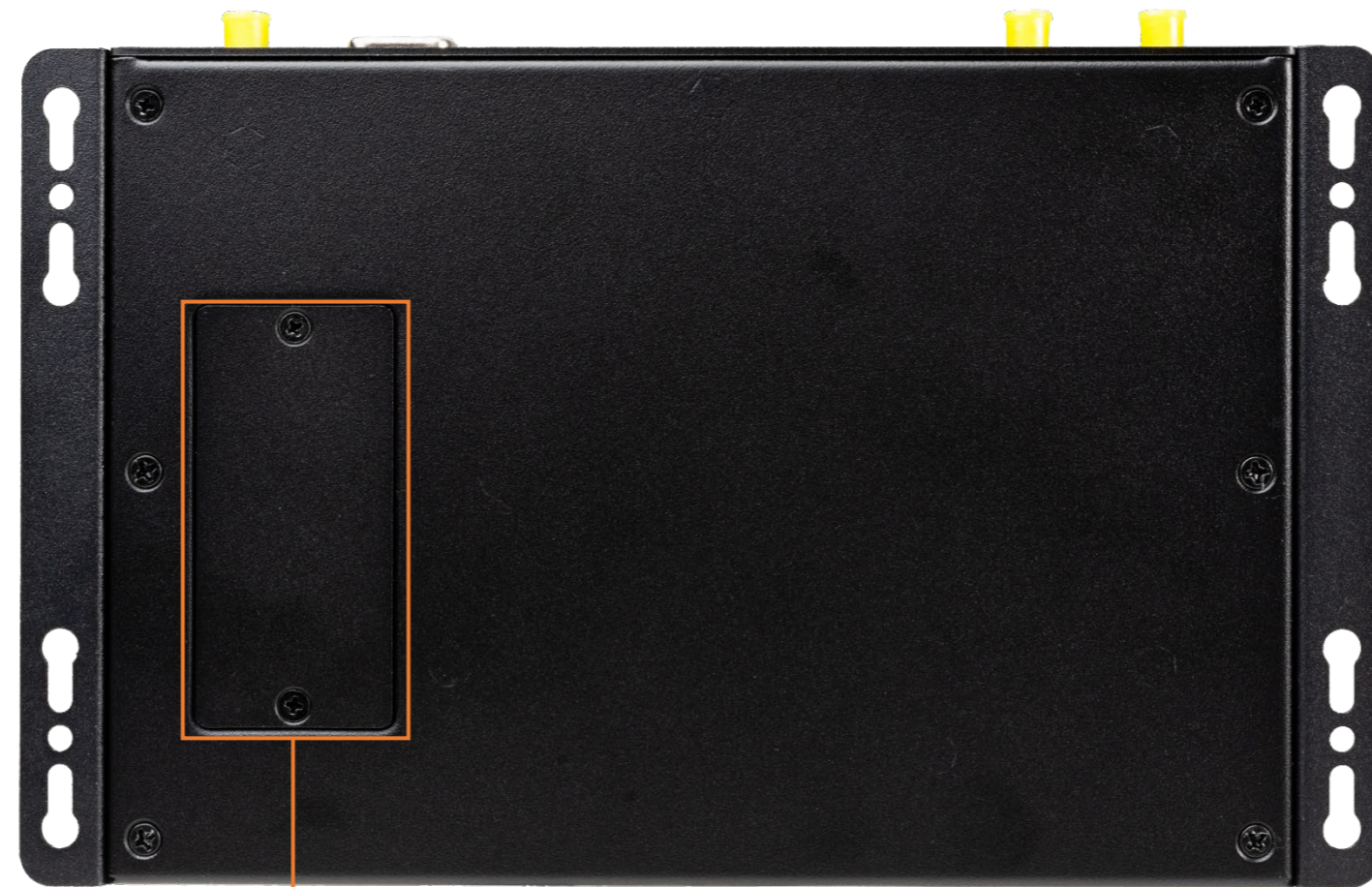

**M.2 SATA3.0**  
Expandable 2242 SATA SSD

# Dimension



EC-A1684XJD4

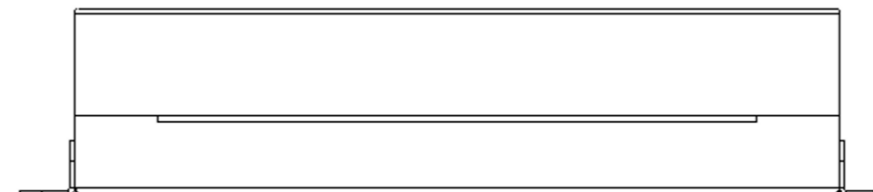
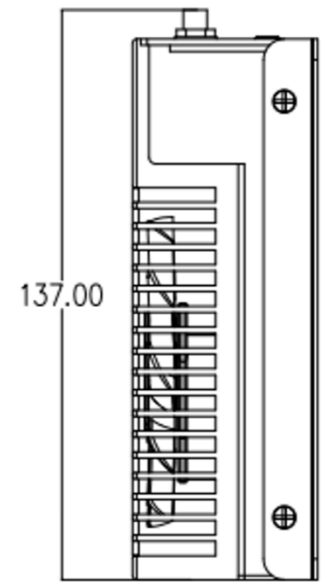
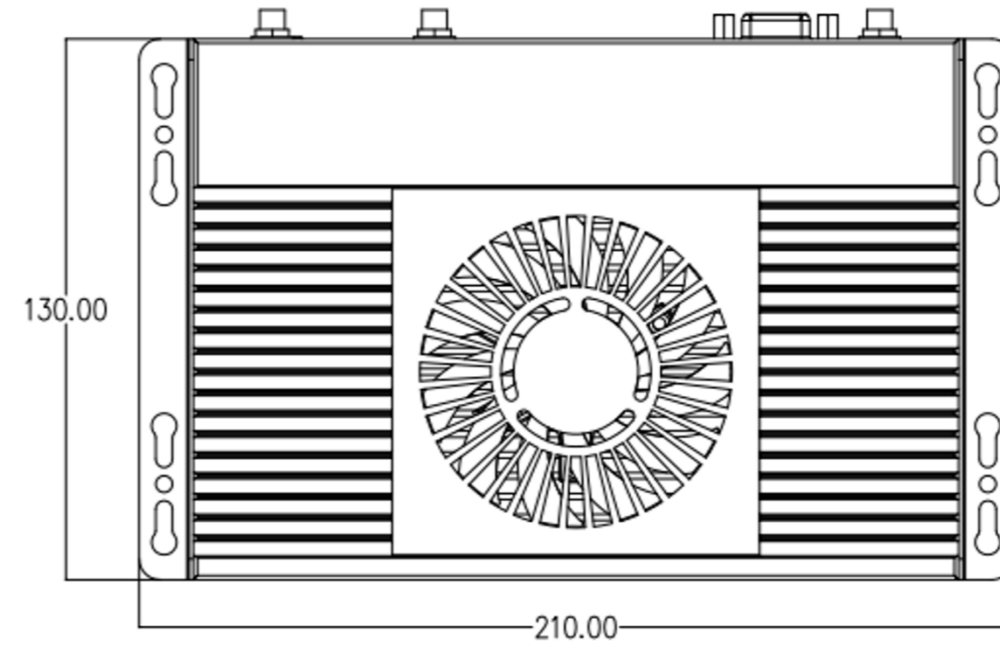
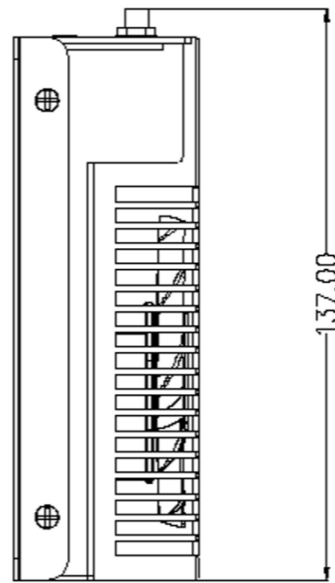
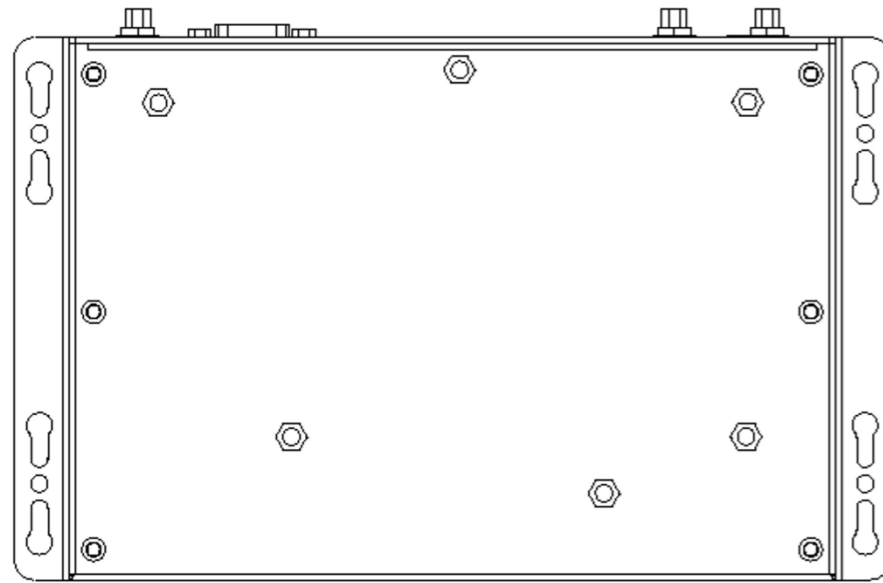
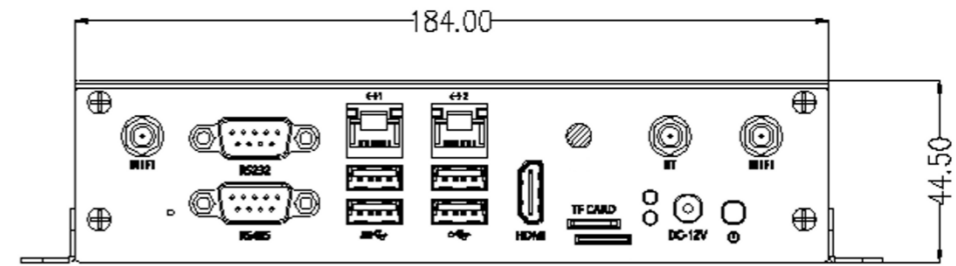



# Dimension



EC-A1684XJD4 V2

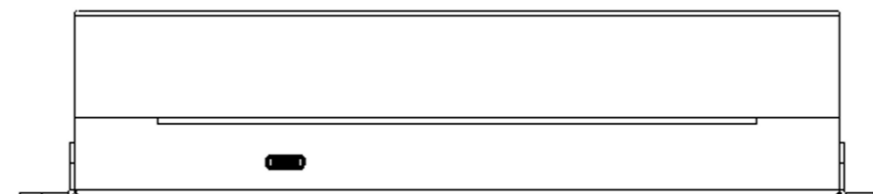
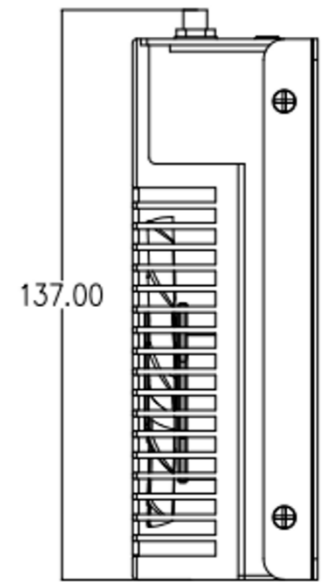
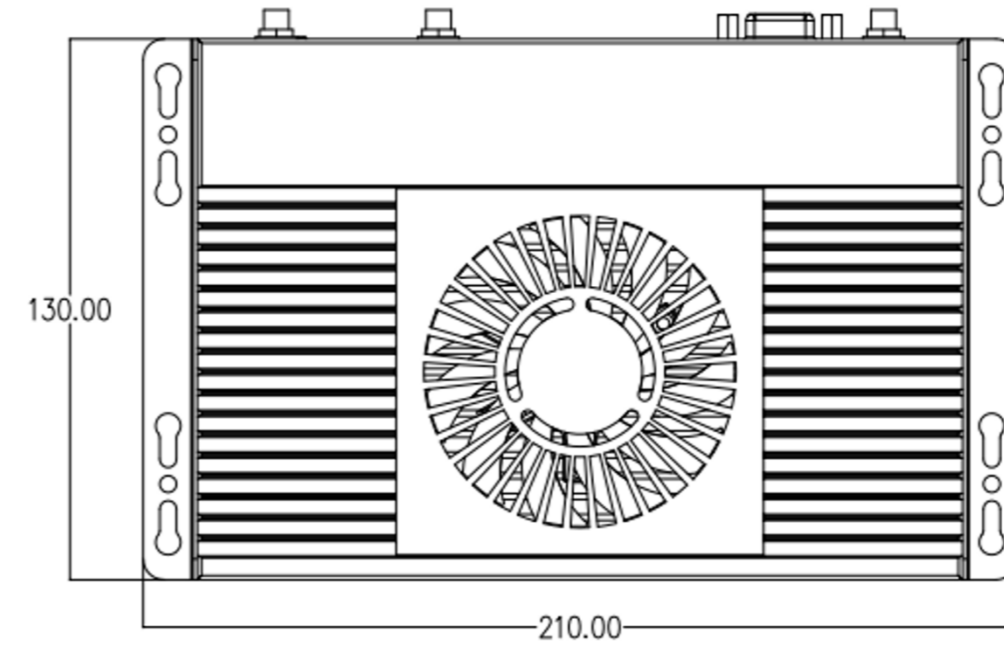
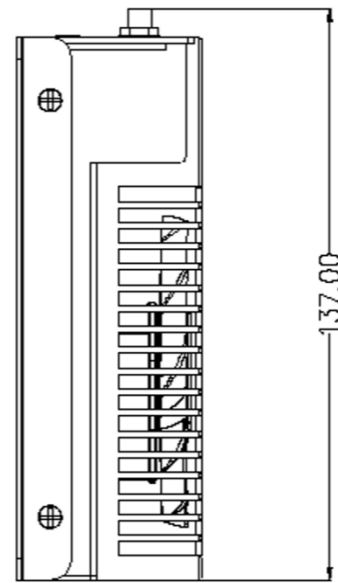
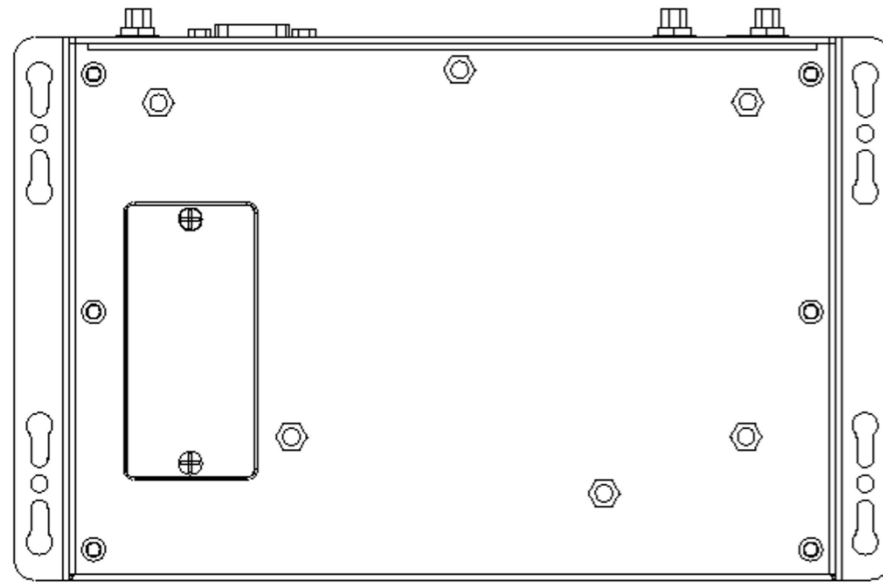
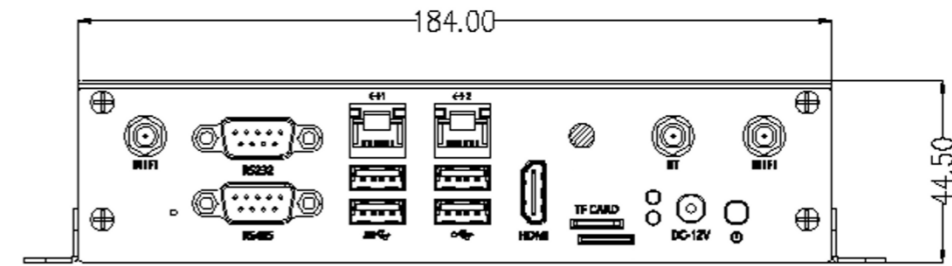



## T-CHIP INTELLIGENCE TECHNOLOGY

---



Contact Us  
(+86)18688117175



E-mail  
global@t-firefly.com



Website  
<https://en.t-firefly.com/>



Address  
Room 2101, Hongyu Building, #57 Zhongshan 4Rd, East District,  
Zhongshan, Guangdong, China.