



# ROC-RK3328-CC

## Product Specifications

<b>Author</b>	T-chip Intelligent Technology Co.,Ltd.
<b>Version</b>	V1.0
<b>Date</b>	2018-06-23

<b>Version</b>	<b>Date</b>	<b>Updated content</b>
V1.0	2018-06-23	Original version



# Directory

1. Product Overview .....	4
1.1 Overview .....	4
1.2 Application Scenarios.....	4
2. Hardware Specifications .....	5
3. Interface description.....	6
4. PCB Size.....	7
5. Pin definition.....	8
6. Operation System .....	10
7. Electrical Description .....	10
8. Appendix.....	11
8.1 Source code acquisition .....	11
8.2 Contact us .....	11

## Company Profile

T-Chip Intelligent Technology Co., Ltd. was founded in 2005. It has more than 10 years of research and development experience in scientific and technological products, has 6 invention patents and more than 30 computer software copyrights, and is a national high-tech enterprise. We focus on the research and development, design, production and sales of open source intelligent hardware, internet of things and digital audio products, and provide the overall solution for intelligent hardware products meanwhile.



Firefly is a brand owned by T-chip Technology. It operates open source products, open source communities and online stores. It has a large number of enterprise users and developer users, and its products are well received by users. Firefly open source products include open source boards, core boards, industry mainboards, etc. The open-source board series is the recommended board card by chip original factory Rockchip and obtain the support of native SDK. The core boards and industrial mainboards are widely used in commercial displays, advertisement integrated machines, intelligent POS, face recognition terminals, internet of things, intelligent cities, etc. At present, there are more than 100,000 users, including over 2,000 enterprise users. And well-known users include ARM, Google, Baidu, Tencent, Alibaba, etc.

Firefly team has more than 60 research and development members and has the research and development capabilities in schematic design, PCB layout, mainboard production, embedded development, system development, application program development, etc., which accelerates the research and development process for many technology entrepreneurs and start-ups, and provides professional technical services..

" **Make technology more simple, Make life more intelligent** " is the idea of Firefly team. We hope to make the research and development of various technology products efficient and simple, and let intelligent technology integrate in our lives through the open source products and technical services of Firefly.

# 1. Product Overview

## 1.1 Overview



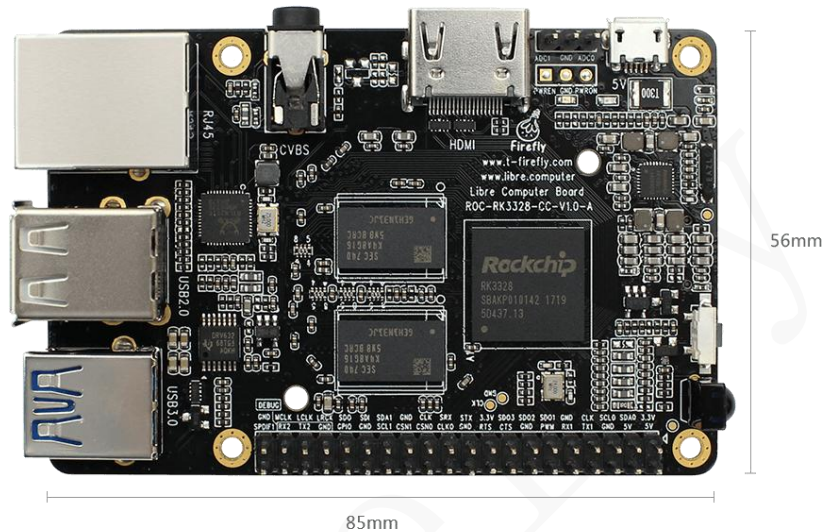





ROC-RK3328-CC is an Open source platform which powered by **RK3328 chipset**. Ultra small credit card size design , **equipped with a Quad-Core Cortex A53 processor, the max frequency reach to 1.5 GHz**. Integrated with a new generation high performance DDR4, Integrated with ARM Mali-450 MP2 Quad-core GPU, support OpenGL ES1.1/2.0, OpenVG1.1, which can run Android and Linux OS in good performance.



High speed data transmission port USB3.0, it's 3 times of USB2.0 which make sure data transmit without delay. Abundant 40pins expansion header which include general GPIO, I2S, SPI, I2C, UART, PWM, SPDIF ,Debug. Unique EMMC storage expansion interface can support external EMMC accessorizes.

Support Android and Ubuntu dual system, can be used for Mini-PC, software development, product application, Media center ,entertainment ,Office and study, smart embed , DIY electronic and so on. With good support of software, open source code, it can reduce the threshold and development cycle, it's a good choice for smart project development.

## 1.2 Application Scenarios

			
Amusement equipment	Commercial display	Medical / health equipment	Vending machines
			
mobile POS machines	Interactive printer	Smart robot	Industrial computer



## 2. Hardware Specifications

Item	Specification
SOC	Rockchip RK3328
CPU	Quad-Core ARM® Cortex-A53 64-bit processor, Frequency up to 1.5GHz
GPU	ARM Mali-450 MP2 GPU Support OpenGL ES1.1/2.0, OpenVG1.1
VPU	Support 4K VP9 and 4K 10bits H265 / H264 video decoding, up to 60fps 1080P multi-format video decoding(WMV, MPEG-1/2/4, VP9, H.264, H.265) 1080P video coding, support H.264/H.265 Video postprocessor: de-interlacing, denoising , edge / detail / color optimization
Memory	1GB/2GB/4GB DDR4 RAM
Storage	High-Speed eMMC extension interface MicroSD (TF) Card Slot
Ethernet	10/100/1000Mbps Ethernet
Display	1 x HDMI 2.0 ( Type-A ), support maximum 4K@60Hz display 1x TV out, CVBS display, in accordance with 480i, 576i standard
Audio	1 x SPDIF, for audio output 1 x I2S, support 8 channels
USB	2 x USB2.0 HOST, 1 x USB3.0 HOST
IR	1 x IR Receiver Module, Support self-defined IR remote
LED	1 x Power Status LED (Blue), 1 x User Defined LED (Green)
Button	1 x Recover Button
Debugging	1 x Serial Console, for debugging
Interface	40pins 2.54 mm header: support I2S、SPI、I2Cx2、UARTx2、PWM、SPDIF interfaces
Power	DC 5V - 2A ( via Micro USB)
OS	Android 7.1.1 , Ubuntu 16.04 , Debian, LibreELEC
Programming	C、C++、Java、Shell、Python etc
PCB Size	85mm x 56mm ( 8 Layer design, Immersion gold process )
Weight	36g



### 3. Interface description

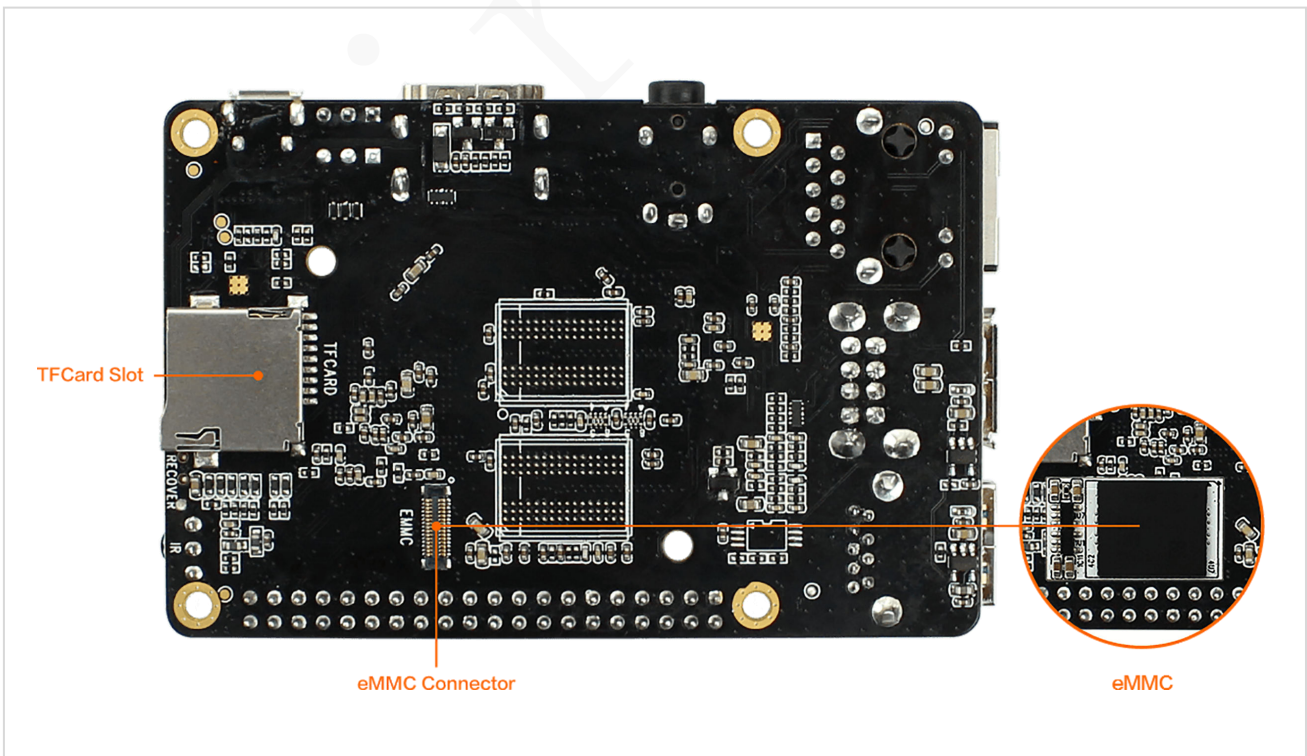
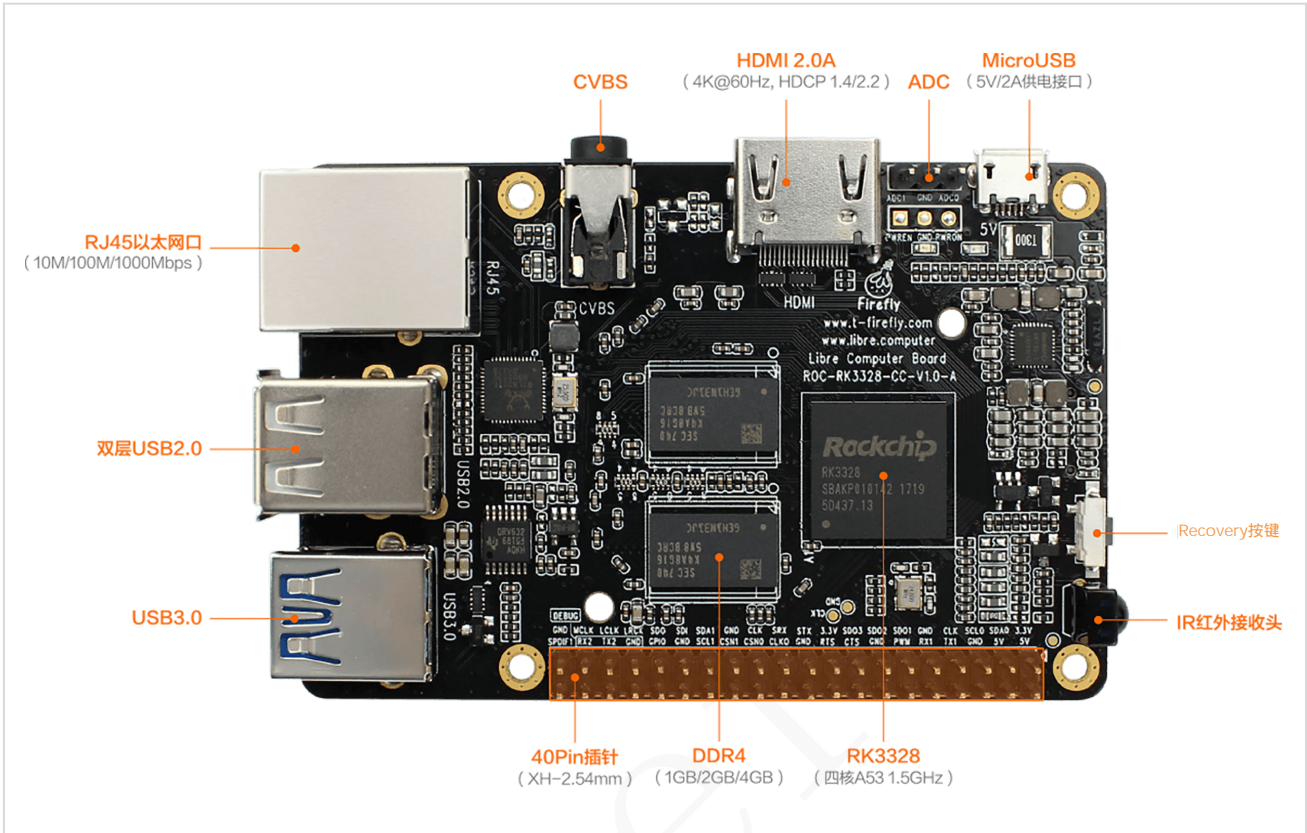

### 4. PCB Size

TOP ( unit : MM )

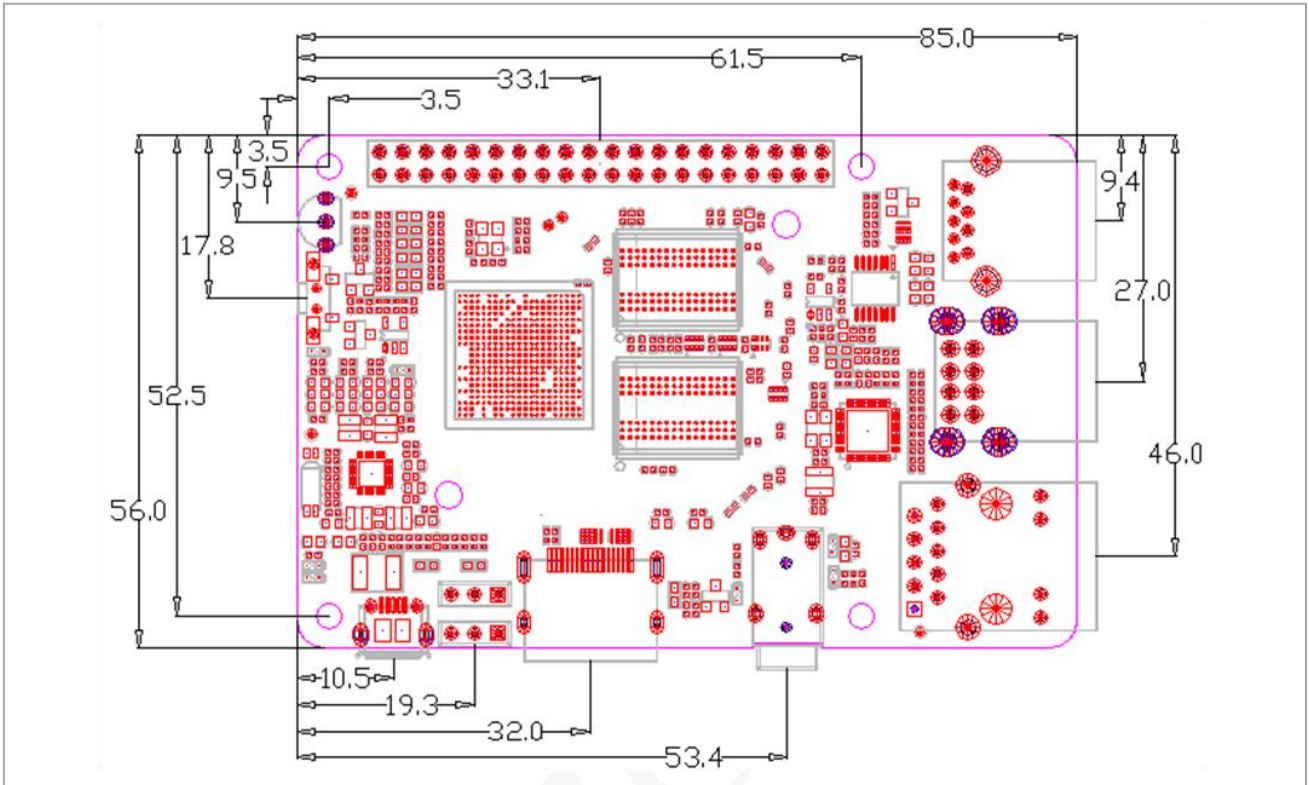

Bottom ( unit : MM )

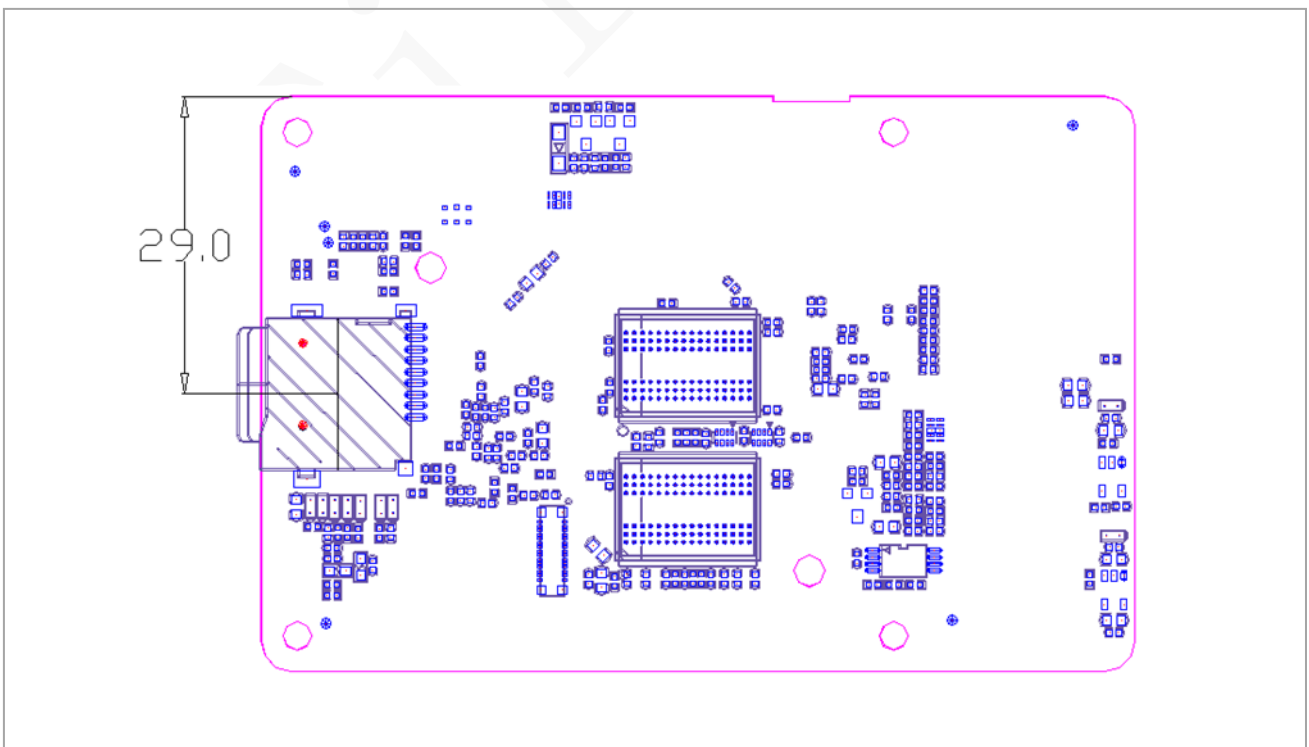

### 5. Pin definition

Abundant expansion pins on ROC-RK3328-CC, such as : PWM、SDA1、SDA0、MCLK、SDI、UART1 and GPIO and power interfaces, shows as follow:

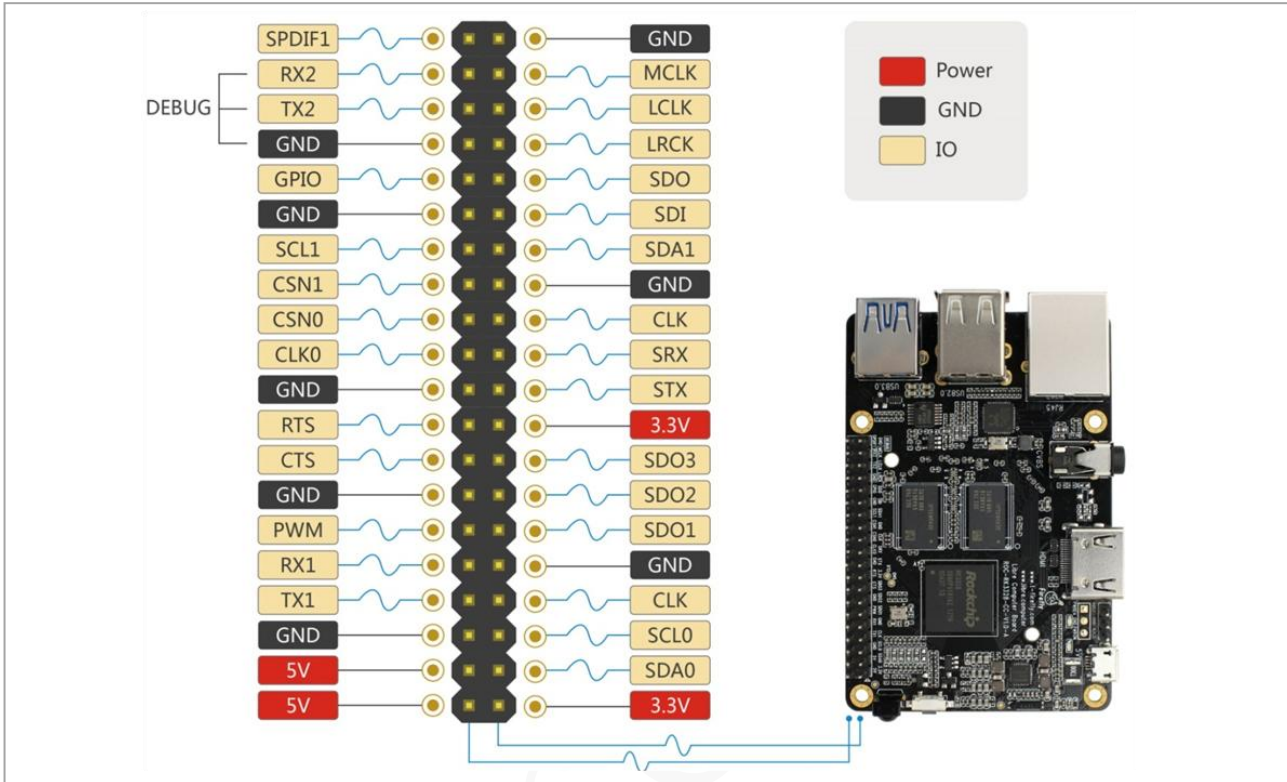

No.	Definition	Attribute	Description
1	VCC_IO	Power output	3.3V output
2	VCC_SYS	Power output	5V output
3	I2C0_SDA	I/O	GPIO2_D1_U/I2C0_SDA
4	VCC_SYS	Power output	5V output
5	I2C0_SCL	I/O	GPIO2_D0_U/I2C0_SCL
6	GND	GND	GND
7	CLK	I/O	GPIO1_D4_D/CLKOUT
8	TX1	I/O	GPIO3_A4_U/UART1_TXD
9	GND	GND	GND
10	RX1	I/O	GPIO3_A6_U/UART1_RXD
11	SDO1	I/O	GPIO2_C4_U/I2S1_SDO1
12	PWM	I/O	GPIO2_A6_U/PWM2





13	SDO2	I/O	GPIO2_C5_U/I2S1_SDO2
14	GND	GND	GND
15	SDO3	I/O	GPIO2_C6_U/I2S1_SDO3
16	CTS	I/O	GPIO3_A7_U/UART1_CTSN
17	VCC_IO	Power output	3.3V
18	RTS	I/O	GPIO3_A5_U/UART1_RTSN
19	STX	I/O	GPIO3_A1_U/SPI_TXD
20	GND	GND	GND
21	SRX	I/O	GPIO3_A2_D/SPI_RXD
22	CLK0	I/O	GPIOA2_D/CLKOUT/SPDIF_TX_M2
23	CLK	I/O	GPIO3_A0_U/SPI_CLK
24	CSN0	I/O	GPIO3_B0_D/SPI_CSN0_M2
25	GND	GND	GND
26	CSN1	I/O	GPIO2_B4_U/SPI_CSN1_M0/FLASH_VOL_SEL
27	SDA1	I/O	GPIO2_A4_U/I2C1_SDA
28	SCL1	I/O	GPIO2_A5_U/ I2C1_SCL
29	SDI	I/O	GPIO2_C3_U/I2S1_SDI
30	GND	GND	GND
31	SDO	I/O	GPIO2_C7_U/I2S1_SDO
32	GPIO	I/O	GPIO0_A0_D/CLKOUT_WIFI_M0
33	LRCK	I/O	GPIO2_C0_U/I2S1_LRCK_RX
34	GND	GND	GND
25	LCLK	I/O	GPIO2_C2_D/I2S1_SCLK
36	TX2	I/O	GPIO2_A0_D/UART2_TX
37	MCLK	I/O	GPIO2_B7_D/I2S1_MCLK
38	RX2	I/O	GPIO2_A1_U/UART2_RX
39	GND	GND	GND
40	SPDIF1	I/O	GPIO0_D3_D/SPDIF_TX_M0



## 6. Operation System

Type	Description
OS	Android 7.1.1 , Ubuntu 16.04 , Debian, LibreELEC
Program language	C、C++、Java、Shell、Python, etc
Source code	Android: <a href="https://gitlab.com/TeeFirefly/RK3328-Nougat.git">https://gitlab.com/TeeFirefly/RK3328-Nougat.git</a>
	Linux: <a href="https://github.com/FireflyTeam">https://github.com/FireflyTeam</a>

## 7. Electrical Description

item		Min	General	Max
Voltage Supply	Voltage	---	5V	---
	Ripple	---	102mV	---
Current Supply ( HDMI output , exclude other accessories )	Working current	---	350mA	900mA
	Standby current	---	250mA	---
Standby power consumption	Working current	250 mA ( Shallow dormancy )		
Environment	Humidity	80%		

## 8. Appendix

### 8.1 Source code acquisition

Please visit the official website "Resource Download": ( [please click here](#) )

### 8.2 Contact us

	Company	T-chip Intelligent Technology Co.,Ltd.
	Address	Room 2101, No.1 Hongyu Building, #57 Zhongshan 4Rd, East District, Zhongshan, Guangdong
	Mobile	(+86) 186 8811 7175
	National service hotline	4001-511-533
	Telephone	0760-89881218
	Zip code	528400
	Business	sales@t-firefly.com
	Website	www.t-firefly.com